



# ÜKY/Duopel Boilers User Manual



**ÜNLÜSOY**

Yapı Malzemeleri Sanayi ve Ticaret Ltd. Şti.  
Pancar Organize Sanayi Bölgesi, 2. Etap No:2, Torbalı - İZMİR, TURKEY  
Tel: +90 444 35 32, Fax: +90 232 469 2412  
[www.unmak.com](http://www.unmak.com)



**INDEX**

---

INDEX..... 1

INTRODUCTION ..... 2

TRANSPORT AND CARRY ..... 3

SELECTION of INSTALLATION PLACE..... 4

SAFETY NOTICES ..... 6

ELECTRIC INSTALLATION INSTRUCTIONS..... 8

INFORMATION ABOUT COMBUSTION..... 10

BOILER FEATURERS ..... 12

RULES FOR HEATING INSTALLATION ..... 14

CONTROL PANEL AND USER INTERFACE ..... 17

START UP ..... 19

FUEL FEEDING – STANDBY ADJUSTMENT..... 22

CARE AND BOILER CLEANING ..... 23

INFORMATION ON USAGE ERRORS..... 24

Dok.03 200401

---

This booklet covers:  
**ÜKY/DUOPEL** 25-40-60-80-100

---

## INTRODUCTION

---



Thank you for choosing ÜNMAK ÜKY/DUOPEL series solid fuel boiler. ÜNMAK ÜKY/DUOPEL series boilers are designed to burn wood pellets with burners and to burn wood with manually (by hand) feeding on the water grill.

Please read the user manual carefully before installing and operating your product and keep the user manual for the life of the product. Do not touch or mix any part of the product other than the places allowed in the user manual.

The installation, maintenance and service of the boiler requires expert technical team.

These operating instructions and regulations should be considered for the installation of the boiler, the selection of the appropriate location for the installation, the installation of the boiler water installation and the design of the chimney.

ÜKY / DUOPEL heating boilers only burn pellet fuel in the burner. An aqueous grill is designed in the middle of the boiler to burn large pieces of solid fuel. Block wood can be easily burned on this grid.

These boilers are used only for heating heating installations, not directly for domestic water heating. However, it can produce hot tap water with the help of a boiler or heat exchanger. The energy required for potable water will be taken from the boiler energy.

ÜKY / DUOPEL heating boilers convert the chemical energy of the wood thrown into the pellet or water grill in the burner into heat energy by combustion and load it on the heating fluid water. Excessive digits of the burner feed setting by entering more than necessary will cause excessive fuel to fall into the combustion chamber, and will take longer to burn the fuel.

Combustion circuit, fan, feeding helix and system pump control are carried out by the electronic control panel supplied with the boiler.

ÜKY / DUOPEL heating boilers can only burn pellet fuels with a burner. Since the powdered fuels will fly inside the combustion chamber with the system fan, there will be no efficient combustion. Since powdered fuel will collect more moisture, it will even cause spiral blockage in the feed screw. Depending on the calorific values of the fuels, the heat passing from the boiler to the water may exceed the declared values.



***Your user manual must be carefully read and kept with the warranty certificate enclosed, for the lifetime of the boiler.***

---

## TRANSPORT AND CARRY

---

ÜNMAK ÜKY / DUOPEL series boilers are manufactured from welded thick sheet metal. Boilers are packed in one piece.

1. Boiler Group: Boiler insulation and outer jacket are shipped dressed.
2. Accessories: Control panel, pump (pump is supplied for capacities below 60 kW power), user manual with warranty certificate and boiler accessories are included in the boiler package.

### Safe transportation of the product

DUOPEL group boilers are heavy products, so care should be taken when moving the boiler to the place where it will be installed. Therefore, the equipment to be used to lift and transport the product should be at a sufficient capacity. In order not to damage the boiler outer sheets and the boiler during transportation;



While carrying the rope on the forklifts on the chassis and carrying the boiler with the help of a crane or hoist, care should be taken not to damage the painted thin sheets of the boiler and the gearmotor-fan group under the hopper.

It is convenient to lift the boiler from the forklift stands or the transport ring on the boiler. The boiler standing on the ground must be lifted directly without a puller. When carrying in cold weather, the boiler should not be lifted suddenly in case the rope freezes from the cold.



***Care should be taken not to damage the gearbox and fan under the hopper.***



***When removing the packaging around the boiler, hard and sharp objects should not be used in order to prevent damage to the painted boiler plates underneath the packaging.***

## SELECTION of INSTALLATION PLACE

---

The place where the boiler is installed must have enough free space for the installation, burning and maintenance of the boiler. For the service need, the gearbox and the group to which the shaft is connected should be distant from the wall to easily come out. For this, the dimensions in the paragraph titled "Mounting location dimensions" should be applied.

In addition, there should be a sufficient amount of clean air circulation for efficient combustion, the chimney design must meet the required draft values for the model used and comply with the construction criteria and related regulations given in the manual. The boiler should never be installed in open spaces, balconies, living areas (kitchen, living room, bathroom, bedroom), in places with explosive and easily flammable materials.

The door of the boiler room should not be opened directly to the escape staircase or general use stairs and must be opened to a security hall. There should be at least one door in boiler rooms with thermal capacities between 50 kW and 100 kW, and at least 2 exit doors in boiler rooms with a floor area over 100 m<sup>2</sup>. The exit doors should be placed in the opposite direction of each other as much as possible, they should be resistant to fire for at least 90 minutes, smoke-tight and capable of self-closing.

At least one of the doors must open directly outside and outside the building. If it is possible to open a door directly outside the building from the boiler room, this is the most suitable solution. The door of the boiler room should not be opened directly to the escape staircase or general use staircases and must be opened to a common hallway or corridor.

A threshold of at least 10 cm height is recommended for the doors opening from the boiler room into the building. If it is possible to illuminate the boiler room naturally, it should be noted that the lighting openings do not come under other windows of the building. If artificial lighting is made, a system that does not dazzle but brightens the apartment should be installed. The main switches and panels belonging to the boiler room should be placed around the entrance door and should be leak-proof type. A fire tube must be kept in the boiler rooms.

One of the purposes of placing the boiler on the concrete base in the boiler room is to prevent the fan from sucking dust from the floor. Ventilation can be done naturally or algebraically. It should be ensured that the fresh air inlet chimney mouth is at the ground level and the dirty air tapping chimney mouth is at the ceiling level.

At least 1 6 kg multi-purpose dry chemical powder extinguishing device should be kept in the boiler room. If natural gas or liquid fuel boilers are also used in the same boiler room, the tear surface must be designed.

The established place must have grilles which are directly connected to the external environment and allow fresh air to enter. One of the culverts should be at most 40 cm below the boiler room ceiling and the other should be at most 50 cm above the floor. These culverts should be constantly open. The lower grill must be at least 40 x 40 cm and the top grill must be at least 30 x 30 cm. Pets

should not be fed in the heating area (boiler room), smoke and food and beverage that may be affected should not be stored.

All electrical and water installations must be done by authorized plumbers, in accordance with any applicable legal and technical rules, approved by the relevant legal entities. The fuels to be burned in the boiler should be kept in a way to maintain a distance of at least 800 mm from the boiler. It is recommended to store fuels in a separate location.

Boilers should be installed on a concrete base at a height of 10 cm from the floor to protect water from moisture and solid fuel from ash dust. The concrete base prevents the fan from absorbing fuel or ash dust on the ground. Laying the mounting place with tiles and tile stones makes cleaning easier.



***It is inconvenient to keep flammable, burning and easily flammable substances in the boiler room.***

#### **Mounting location dimensions:**

The boiler room should be sized to provide the minimum dimensions given in the picture below. While placing the boiler, it is necessary to leave sufficient distance for the fuel to be added to the hopper easily, the gearmotor and shaft under the hopper can be easily removed, and the service can work comfortably.

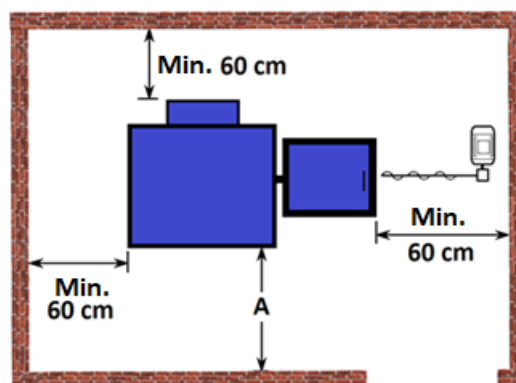

Dimension A: 60 cm more than the opening of the boiler cover;

Dimension B: Must be selected taking into account the shaft disassembly distance.

If the above measurements are complied with, the minimum 8 m<sup>3</sup> volume requirement given in the regulations is ensured.



***There should be no faulty electrical line in the boiler room..***



***The 230 V electrical connection from the control panel must be connected to the mains via the W automat.***

## SAFETY NOTICES



**Electrical installation of this product must be done by qualified personnel in accordance with the explanations given in this manual and applicable local or national regulations.**



**THIS PRODUCT MUST BE CONNECTED TO THE ELECTRICITY WITH EARTH LINE!**

The boiler must be connected to a chimney in accordance with the specifications specified in the user manual and the relevant regulations. The chimney must provide the draft value required by the connected boiler. The boiler must not be operated without a flue connection and there must be sufficient draft for combustion. The boiler should not be operated in the chimneys where sufficient draft is not provided. Any malfunctioning electrical installation in the place where the boiler is installed should be removed.

In case of changing the boiler in the boiler rooms, the old boiler should be removed or the connection with the chimney should be ensured and the sealing place should be sealed and insulated. Under no circumstances should more than one boiler be connected to the same chimney. The cylindrical chimney can be passed through the chimney in the figure.

Smoke shafts should not be placed on the outer wall of the building unless there is a technical requirement. The wall thickness of the chimney walls should not be less than the thickness of a brick. Hollow brick and briquette should never be used in chimney construction. It should be plastered inside and outside and cylindrical pipe inserted into the rectangular chimney.

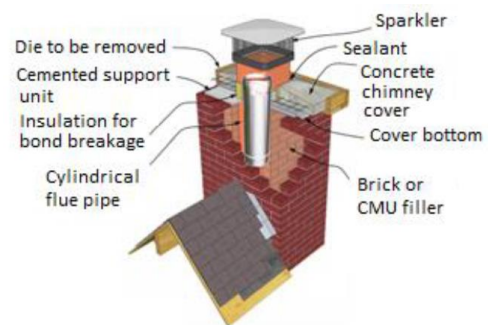

It should be ensured that fresh air always enters the area where the boiler is installed. The dimensions mentioned in the guide should be taken as reference in this regard. The boiler must not be installed in any place directly connected to the living areas or to such a place. To reduce the risk of calcification and corrosion in old and new installations, the instructions given in the relevant section of this manual should be followed by the installer installing the boiler. In particular, if the boiler is connected to an old installation, it is necessary to completely clean the waste inside the installation before installation. The installation should be washed several times.

Avoid excessive fuel loading into the boiler and the suitability of the feeding-waiting settings given in the user manual should be checked. These settings, which indicate the working and stopping time of the gearmotor, the chimney features (draft difference, etc.) to which the boiler is connected, ambient conditions, the thermal comfort requirement of the space, the insulation of the space, etc. varies depending on many parameters. When the settings given in the catalogue are given to operate at a lower power than they are given for the boiler to operate at maximum power, the settings are;

burning should be done by observing. Adjusting the unburned pellet to prevent it from falling down from the burner will be suitable for both boiler efficiency and economy.

Since the fuel particles and fuel ashes burning and flying inside the boiler will easily come out from the open door, the covers of the boiler must not be opened while the fan is operating. While the boiler is burning, the covers should not be opened and manual loading should be made on the burner or inside the boiler.



***The electrical connection should never be disconnected while the boiler is operating.***

For any reason, direct cold water should not be added to the overheated boiler for cooling purposes. This can lead to noise in the installation, extremely high thermal stresses in the boiler and thus permanent damage. Unless there is a risk of maintenance or freezing, water in the installation should not be drained. The system design should ensure that the proportion between the installation water flow rate and the boiler power and the 20°C difference between the boiler inlet and outlet water temperatures are not exceeded. To minimize the completion of water lost in the installation, the water level should be checked regularly and leaks in the system should be eliminated. Because excessive water additions to the system will cause lime accumulation on the water side of the boiler, which will cause regional overheating and this will damage the boiler.

The boiler does not burn directly, it should be installed on a flat surface. It is recommended that the height of the base on which the boiler is to be installed is at least 10 cm and its width is wider than the outer dimensions of the boiler. Thanks to the pedestal, the boiler will be protected from water that can accumulate on the floor, and the fan will be prevented from sucking dust from the floor.



***It should be added to the hopper before the fuel runs out.***



***While loading fuel, the hopper sieve should not be removed, the hopper cover should be closed after loading.***



***Adding fresh water to the installation should be done when the system is cold***

.



## ELECTRIC INSTALLATION INSTRUCTIONS

---

ÜNMAK ÜKY / DUOPEL series boilers are fed with 230 Volt mains voltage. Where the mains voltage is less than ten percent or greater than ten percent, the regulator should be used. The control panel should be connected to a wall panel with suitable grounding equipment, the distance between the boiler panel and this wall panel should not exceed 50 cm.

For each boiler room, separate grounding installation should be made from the column installation. Grounding installation:

- a) 0.5 m<sup>2</sup>, 2 mm. thick copper sheet,
- b) 0.5 m<sup>2</sup>, 3 mm. thick galvanized plate (hot dip) or
- c) Solid copper rod should be made with electrodes.

Copper rod electrodes must be at least 1.5 m in diameter of  $\varnothing 16$  mm or at least 1.25 m in diameter of  $\varnothing 20$  mm and the earthing resistance of rod electrodes must remain below the limits of 20  $\Omega$ . (Neutral-Earth voltage  $\leq 3V$ )

In all three cases, copper electrodes or plates must be connected to the natural gas installation by soldering or welding, using a minimum of 16 mm<sup>2</sup> multi-stranded (braided) copper cable and conductive lug. Copper electrodes or plates should be placed completely in the ground as teeth, and the conductor remaining on the ground should be connected with the pipe casing and the main table of the boiler room.



***THIS PRODUCT MUST BE CONNECTED TO A SAFE EARTH LINE!***



***The boiler must be closed and should not be installed in living spaces.***



Electrical Connection Scheme

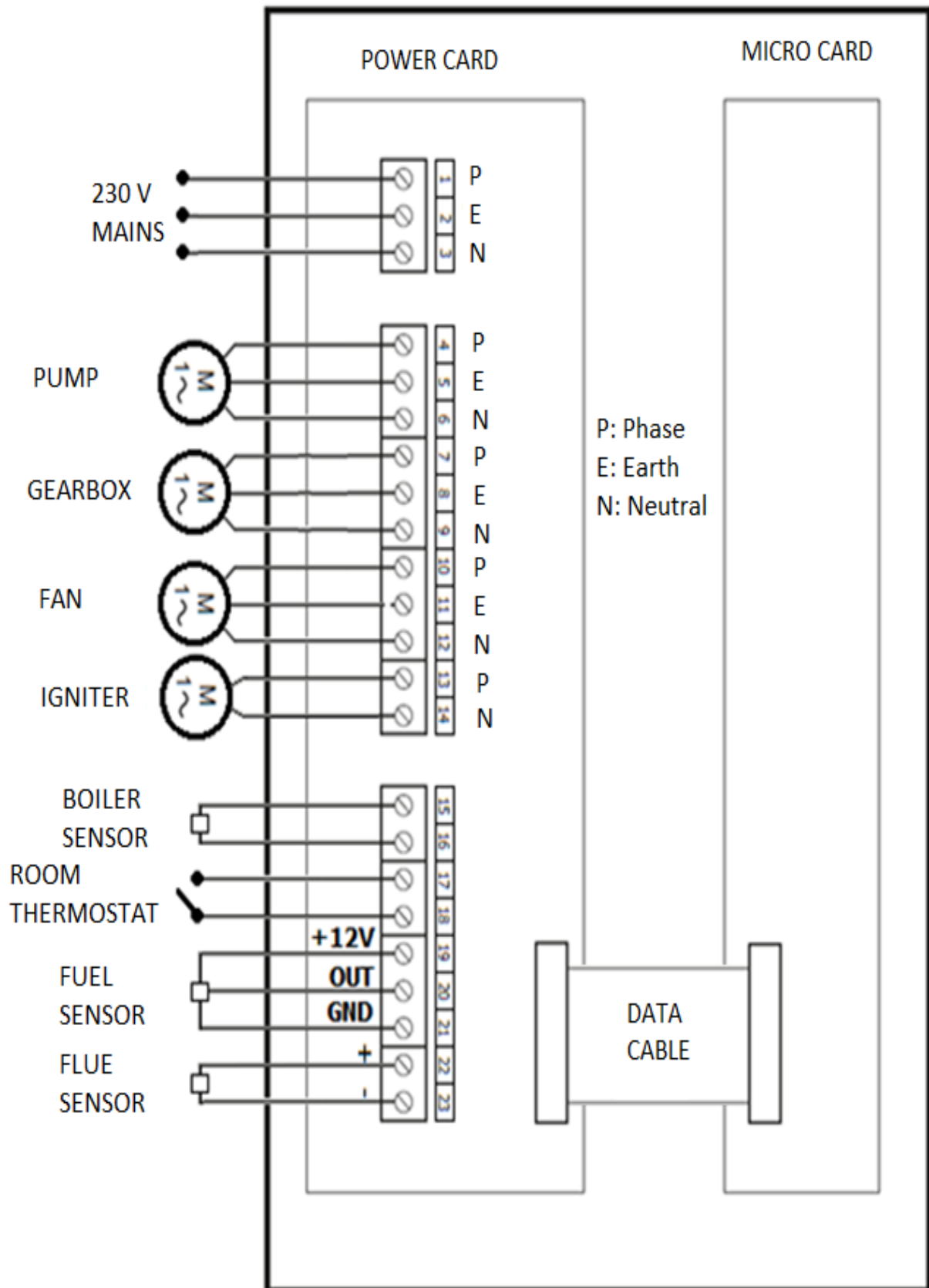

**INFORMATION ABOUT COMBUSTION**

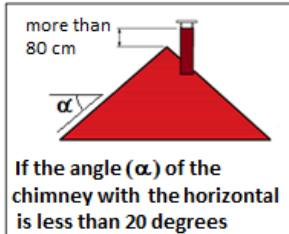
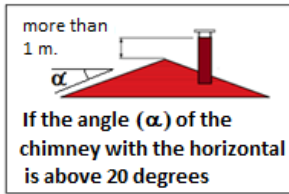

As a general rule, the air supplied to the fuel should be at a certain rate to ensure correct combustion. So the fan speed should be adjusted well. The air required for a certain amount of fuel should not be too much. If the amount of air varying depending on the type of fuel is less than necessary, carbon monoxide is formed, the energy produced decreases, processing begins, the combustion efficiency decreases, when the amount of air is more than necessary, while the carbon monoxide decreases, the air that does not enter the combustion is removed from the chimney by being heated in the furnace, combustion deteriorates, combustion efficiency. It decreases.

If the flue gas temperature is above the accepted values, much energy will be thrown from the flue to the atmosphere. The material, construction and connection of the chimneys are important in terms of high combustion efficiency, low heating costs and environmental protection.

For the combustion to be good, the chimney must also be good. High temperature resistant firebrick and stainless steel chimneys are recommended as a material. Horizontal smoke channels should be connected to the chimney with a rising slope of at least 5% and its length should never exceed 1/4 of the chimney height. The height of the chimney should be determined well and the chimney rising from the building should rise at least 80 cm from the ridge. Unless compulsory, the chimney sections should be circular.

Perforated bricks should never be used on chimney walls. Ideally, it is knitted with firebrick. ÜNMAK boilers should be connected to an independent chimney that can provide the minimum desired minimum draft. Minimum draft is generally min. It should be measured with a manometer in 20 Pa. The part of the waste gas line between the boiler and the chimney should be insulated with glass wool. The flue gas pipe and chimney should be made of steel sheet or material resistant to around 400 °C. All connections on the flue gas pipe must be sealed for better combustion and efficiency. The waste gas pipe should be connected to the chimney in the shortest way, within the dimensions given in the diagram below. Horizontal connections and equipment such as elbows that reduce draft should be avoided.

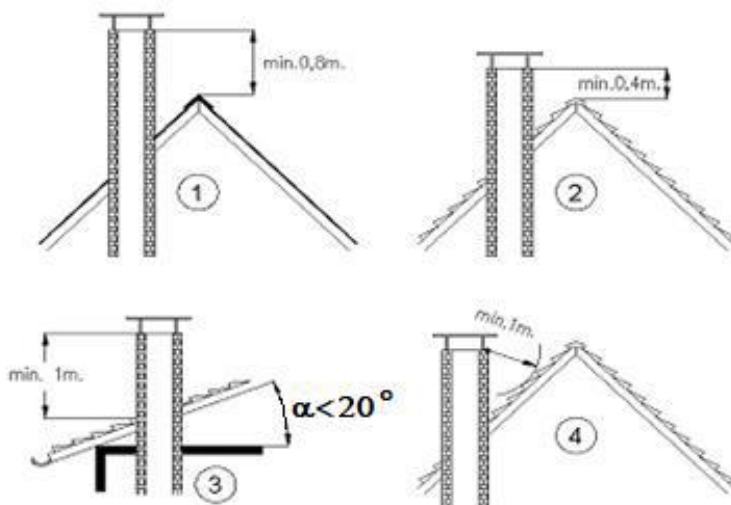

sealed steel.

A vertical singular steel pipe should not be used as a chimney, the chimney must have an inner and an outer surface. The outer surface may be steel or brick braided. For the inner surface of the chimney, corrosion-resistant stainless steel can be preferred. To prevent condensation, thermal insulation should be made in the gap between the inner and outer surface of the chimney. At the lowest level of the chimney, there should be a cleaning cover made of all kinds of

The length of the waste gas pipe between the flue and the boiler should not exceed one quarter of the height of the flue.

The size of the flue gas pipe and the chimney should be larger than the flue gas outlet (flue) dimensions of the boiler. The boiler chimney installed must be at least 1 meter above flat roofs and at least 0.4 meters above tiled roofs.

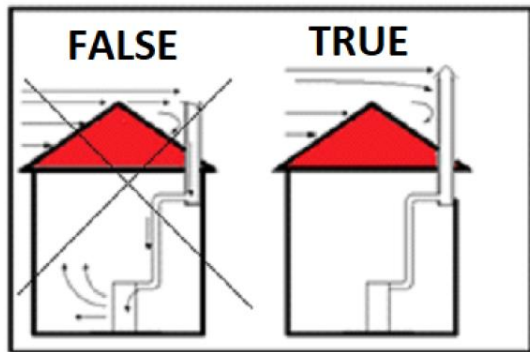

Chimney without flue hat and with flue hat

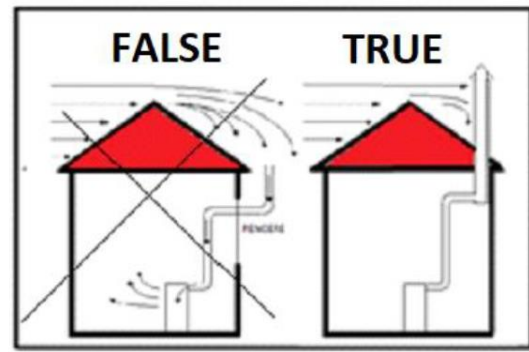

Incorrect installation chimney and correctly installed chimney hat



***Excess air at high flue temperature, high flue temperature also causes loss of combustion efficiency.***



***Excess air causes high flue temperature and high flue temperature causes loss in combustion efficiency.***



***It will be appropriate to take some samples before taking bulk amount of the fuel you will use in the boiler, and if it is suitable for burning, take the remaining amount. Make sure that the sample you will receive is not wet or damp and it is a pine pellet.***

## BOILER FEATUTURES

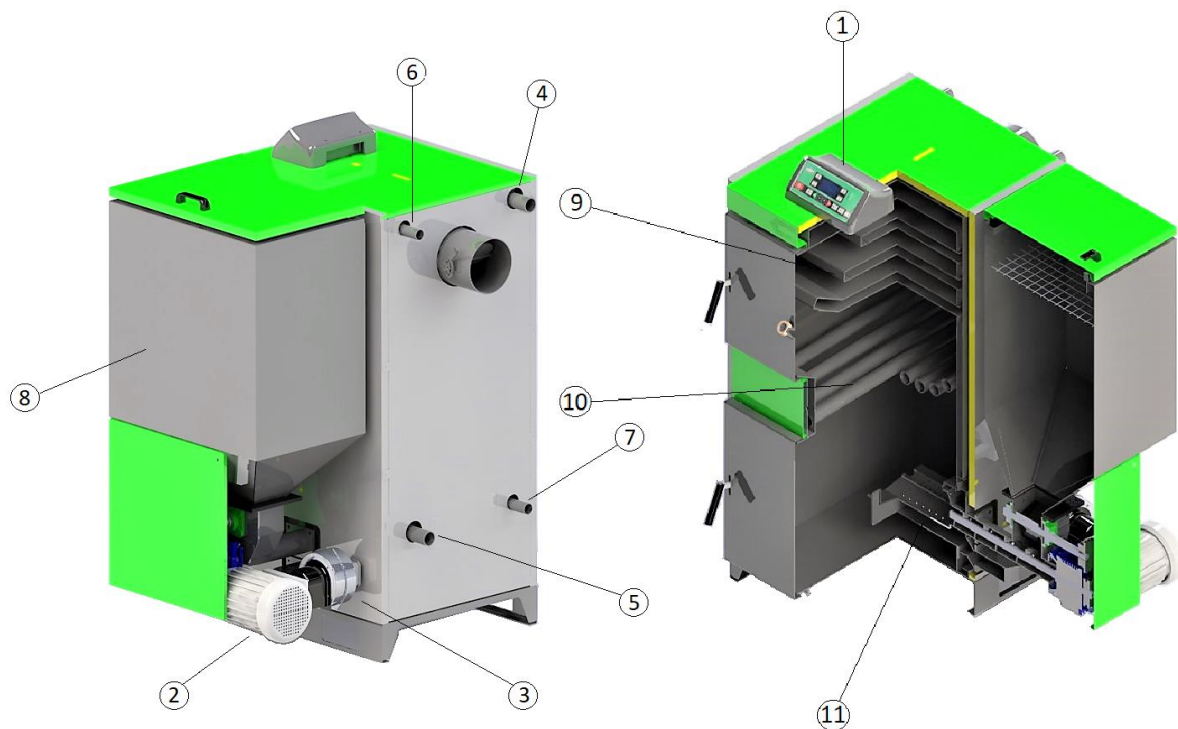

- 1. Control panel
- 2. Gearmotor
- 3. Fan
- 4. Hot water flow

- 5. Return line
- 6. Safety flow
- 7. Safety return
- 8. Hopper

- 9. Water jackets
- 10. Grid for log wood burning
- 11. Wood pellet burner

1. Control panel: It is the electronic box that blows the boiler. It controls when the gearbox, motor, fan, pump stop and when to run. The temperature values read while controlling are effective.
2. Geared motor: It is used to increase the power by decreasing the speed of the motor. The movement of the auger gives the gearmotor. The safety device in the pellet feed line also gets its movement from this gearmotor.
3. Fan: It is the fan that provides the combustion air. It can be adjusted to operate at the desired speed from the control panel.
4. Hot water flow line: It is the flow pipe to the radiators or heating system. The water heated in the boiler is sent to the radiators or heating installation from this pipe.
5. Return line: It is the pipe through which the water returned from the radiators or heating installation returns to the boiler. It can also be called return pipe or return line.
6. Safety flow line: It can also be called expansion line. It is the line where the expanded water is sent as a safety due to heating in the boiler.
7. Safety return line: It is the line where the water sent from the boiler to the expansion tank is taken back.
8. Hopper: It is the place where the fuel is stored. The power it can take depends on the fuel size.
9. Water jackets: These are specially designed water chambers to circulate the water and circulate the smoke. As the smoke passes between them, it releases its energy and heats the water inside.
10. Grid: These are the pipes used for burning wood. Water passes through the pipes. In this way, both the water inside is warmed and the life of the grid is extended.
11. Pellet burner: It consists of two nested chambers. Pellet fuel is driven from the inside by the helix and the air coming from the outside is blown by the fan. Fan air and fuel meet at the front of the burner.

**ÜKY/DUOPEL Technical Features**

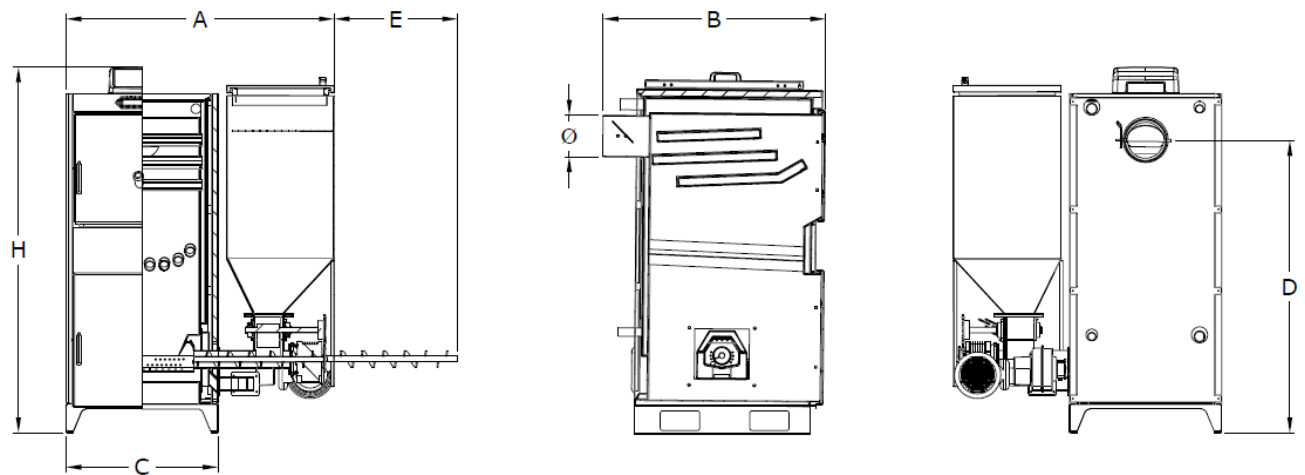

TECHNICAL FEATURES							
MODEL	ÜKY/DUOPEL	25	40	60	80	100	
Fuel Type		Wood Pellet – Log Wood					
Power	kW	25	40	60	80	100	
Burner Barrel Length	mm	250		305			
Hopper Capacity	Lt	215	245	245	245	245	
Wood Loading Capacity	Lt	48	60	75	80	98	
Water Volume	Lt	80	115	150	210	255	
Boiler Weight	kg	310	400	425	510	585	
Draft	Pa	25-28	31-33	33-35	35-40		
Temperature Control Range	°C	40-90					
Return Temperature (Recommended)	°C	40					
Maximum Operation Pressure	bar	3					
Test Pressure	bar	5					
Dimensions	Boiler Width (A)	mm	1090		1185		1272
	Depth (B)	mm	975	1075		1275	1375
	Body Width (C)	mm	550	645			732
	Flue Connection Height (D)	mm	1165	1265			
	Auger Disassembling Distance (E)	mm	600				
	Total Boiler Height (H)	mm	1475	1575			
Flue Connection	mm	130	160	180	220		
Min-Max Flue Temperature	°C	230					
Boiler Flow – Return	R"	1"	1 ¼"	1 ½"	2"		
Safety Flow – Return	R"	1"		1 ¼"	1 ½"		
Discharge Connection	R"	½"					
Electricity	V/Hz	230/50					

## RULES FOR HEATING INSTALLATION

### Circulation pump:

A pump with sufficient capacity and a pump system is recommended. The capacity of the required pump is determined taking into account the resistances formed in the installation. The wiring diagrams given in the manual should be taken as reference to determine the correct position of the pump in the system. The pump stage should be adjusted considering the resistance in the installation.

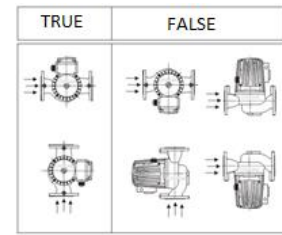

In addition to the schematic installation connection shown in high capacity boiler assemblies, a backup pump system should be made. By-pass line should be connected directly as backup pump line, primary pump. Boiler inlet and outlet lines should be connected with collectors. In order to prevent the system from making air, in open expansion installations, the head of the pump should be less than the height of the expansion.

In the assembly of the circulation pump, the electrical connections not coming down will eliminate the problem of possible water entering into the pump. Vertical mounting of the shaft should also be avoided to prevent the pump shaft from pressing on the body or outer cover during operation.

### Expansion tank:

In hot water heating systems, when the water is heated from 10°C to 90°C, its volume increases by 3.55% of its initial volume. "Expansion tanks" are used to get this expansion depending on the temperature in the water. Expansion tanks also fulfill the safety of the system, that is, the pressure does not rise, and the necessary water supply duties to the system. Since DUOPEL series boilers can also be loaded manually, an open expansion tank is mandatory.

BOILER POWER (kW)	OPEN EXPANSION VOLUME (Lt)
25	50
40	90
60	90
80	110
100	210

It is placed at the top of the system that is, on the roof, works with a level difference and open to the atmosphere. The expansion tank is placed at a slightly higher point than the highest point of the dispensing system to collect the expanding water volume. The water expanding in the boiler is stored in the expansion tank through the flow safety pipe. When the water in the installation cools, the reduced water of the installation is completed by the expansion tank through the return safety pipe. Since the expansion tank opens the system to the atmosphere, it ensures the safety of the system by preventing the pressure in the heating installation from rising above the atmospheric pressure. Air pipes in the system are evacuated by opening the air pipes to the atmosphere from the expansion tank. It is recommended to use separate expansion tanks for each boiler in the installation, according to their capacities. So it is not right to connect two boilers to one expansion tank. There are flow and return safety pipes for each boiler and expansion tank. Valves, check valves etc. on these safety pipes. No fittings such as material should be installed. The safety pipes should reach the nearest point of the boiler inlet and outlet from the shortest vertical path. Horizontal movement is permitted only at the level of the expansion tank and the minimum length.

ÜNMAK DUOPEL series solid fuel boilers must be connected to an installation with an open expansion tank in accordance with the installation scheme shown below. The circulation pump can be connected on the flow or return line. In case the pump is at the return of the boiler; open expansion tank should be higher than the head of the pump.

### Warning about water level:

After the first water is pumped into the system, the minimum water level should be marked on the hydrometer. The water level should be checked daily, and water should be added to the installation when it falls below the minimum value. Open expansion tank volumes, which should be according to Ünmak boiler capacities, are given in the table above. Open expansion tanks are selected by assuming Ünmak brand open expansion volumes and panel radiators in the system.

Open expansion tank installation scheme

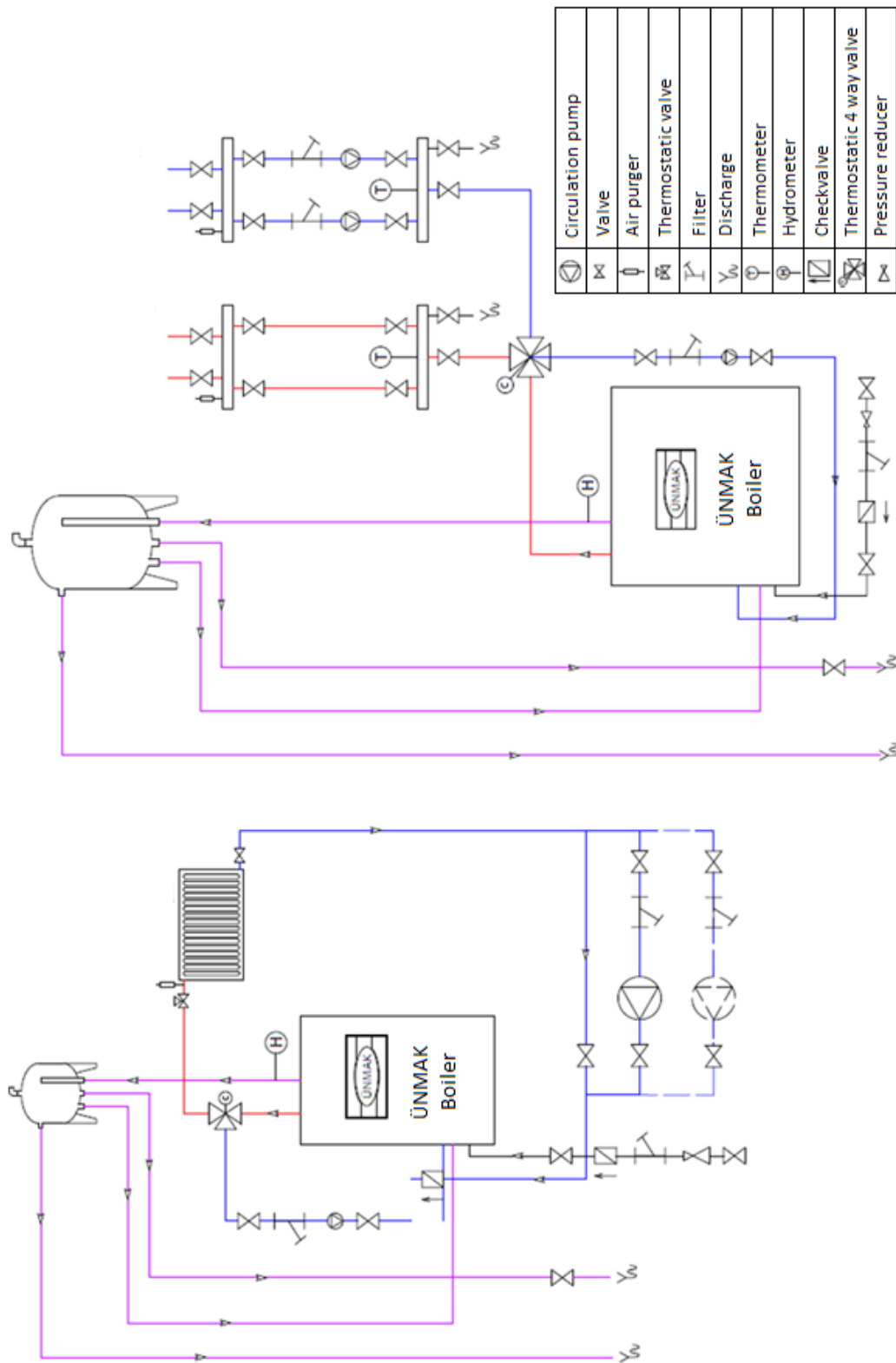



**Warning against corrosion in the installation:**

ÜNMAK boilers are extremely resistant to rust and therefore corrosion. However, all iron-based components (including plumbing pipes and radiators) in the heating installation must be protected against corrosion. Oxygen in the installation water causes rust and therefore material loss as a result of oxidation on iron surfaces.

During the first filling of the installation, the accumulated air must be evacuated. Usually <+ after the first filling

"0+

+

If the necessary precautions are taken, there will be no damage caused by the oxygen in the water.

**Warning against frost protection:**

The heating system must be completely insulated. The parts of the installation that are open to external environments should be more isolated than the interior parts. In the open expansion line, the flow and return pipes must be insulated and even the expansion tank must be insulated.

Matters to be considered in new installations:

System design and sizing should be done correctly to minimize the addition of fresh water. None of the materials used in the installation should be gas permeable. Maximum 50 micron filter with synthetic or metal mesh should be placed on the fresh water addition line.

**Points to be considered for radiators connected to old installations:**

A corrosion protection layer (black magnetite) is formed on metal surfaces in contact with water in a long-term heating system. When a new boiler is installed in the old system, clean surfaces of the boiler will be the first place where corrosion will begin. Therefore, when a new boiler is connected to the old heating system, in addition to the precautions to be taken for the new systems, the following issues should also be considered:

1. Before the old system is connected to the boiler, it should be washed thoroughly to remove any dirt and sediment from it.
2. A manual valve air separator should be placed at the top of the system.



***The installation must be washed several times with water before installing a new boiler in the old heating installation.***



***The chimney must be cleaned before installing the old chimney installations.***



***Each boiler chimney should be detached. Never more than one boiler should be connected to the same flue system.***







---







---

**CONTROL PANEL AND USER INTERFACE**



**Buttons and Descriptions**

<p><b>ON/OFF</b> button</p>		<p>It is used to open and close the control panel.</p>
<p>(+) (-) button</p>		<p>It is used to enter new values into the device. It is used to increase or decrease the values of "Fan Setting", "Temperature Setting", "Fuel Supply", and "Fuel Standby"</p>
<p>ENTER</p>		<p>It is used for storing the set values and for entering submenus from the menu.</p>
<p>ESC</p>		<p>It is used to exit the menu or submenu.</p>
<p>Fan Adjustment</p>		<p>Used to determine fan speed</p>
<p>Temperature Adjustment</p>		<p>It ensures that the boiler water temperature stops when it reaches the set value.</p>

Fuel Feeding		It is used to determine the time when the fuel is put into the burner.
Fuel Stand-by		It is used to determine the waiting time after fueling time.
Gearmotor On/Off		The gearbox motor (fuel loading engine) of the boiler is activated and deactivated with this button.
Fan On/Off		The fan of the boiler is activated and deactivated with this button.
Manuel Fuel Feeding		It is used to manually (manually) add fuel to the boiler. As long as the button is pressed, fueling continues.
Wood Mode		It is used when it is necessary to manually load wood into the boiler. When the button is pressed, the gearbox functions are canceled. Ignition is done manually.



- Fan
- Pump
- Gearmotor
- Ignition
- No Fuel

There are four information and one warning lamp on the control panel. Warning lights come on when the fan, pump, gearmotor and ignition are working. When the fuel runs out, the warning lamp lights up and warns.

**START UP**

The following steps should be followed for boiler start-up:

Check whether there is a visible glitch in the installation. If there is a malfunction, remove the malfunctions by obtaining information from the "Information on Usage Errors" page.

Observe if the water decreases in the installation from the hydrometer. If it does, add water.





Hidrometre

Check for visible defects in the boiler's power line. If there is a malfunction, remove the malfunctions by obtaining information from the "Information on Usage Errors" page.

**To burn pellets with automatic feeding:**

Fill the hopper with wood pellet and close the cap tightly.

Open the control panel by pressing the  ON / OFF button of the device for 1 second. When turned on, values will appear next to Feed, Set Heat, Standby variables on the blue graphic screen.



Since the  **Gearmotor On / Off** and  **Fan On / Off** button are not pressed in the side display, CHECKUP is not visible and the boiler is running.

If the  **Gearmotor On / Off** and  **Fan On / Off** buttons are not pressed for a certain period of time, it will ignite and feed first and then continue firing. Feeling that the temperatures are not rising, it will either warn "Ignition System Failed" or "Fuel Over".

-	<b>26</b> <sup>°</sup>
Feeding : 5 sn.	028 sn
Set Temp. : 40°	
Standby : 00.50	
CHECKUP	B: 27°

-	<b>26</b> <sup>°</sup>
Feeding : 5 sn.	004 sn
Set Temp. : 40°	FEED
Standby : 00.50	
IGNITION FEED.	B: 27°













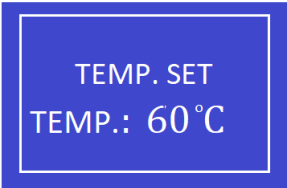



-	<b>26</b> <sup>°</sup>
Feeding : 5 sn.	050 sn
Set Temp. : 40°	STD-BY
Standby : 00.50	
IGNITION	B: 27°

Press the  **Gearmotor On / Off** and  **Fan On / Off** buttons. The gearmotor and fan will be activated and will work to fulfill the boiler heating functions.

-	<b>26</b> <sup>°</sup>
Feeding : 5 sn.	004 sn
Set Temp. : 40°	FEED
Standby : 00.50	
IGNITION FEED.	B: 27°







-	<b>26</b> <sup>°</sup>
Feeding : 5 sn.	050 sn
Set Temp. : 40°	STD-BY
Standby : 00.50	
IGNITION	B: 27°



-=	<b>29</b> <sup>°</sup>
Feeding : 5 sn.	050 sn
Set Temp. : 40°	STD-BY
Standby : 00.50	
HEATING	B: 55°

<p>It is useful to set the boiler water temperature at 60°C for the first time. To do this, first press the  <b>Temperature Setting</b> button on the panel. TEMPERATURE SET will appear on the screen. You can hold down the   buttons until the temperature you want to adjust is reached.</p> <p>When it reaches the desired degree, you can save it by pressing the <b>ENTER</b> button.</p>	
<p>Press the  <b>Fan Setting</b> button of the panel. The rectangle will appear around the line in the upper left corner. When you press the  button once, you increase the fan stage once again, as in the second figure, the moment you press the <b>ENTER</b> button, the fan setting you have memorized and the image on the screen will be as in the third figure. The fan speed will remain at Level 1 during the ignition.</p>	
<p>Find the Fuel Feed and Fuel Standby settings in the "Fuel Standby - Feed Settings" section of your manual, which should be based on the boiler power and fuel type.</p> <p>Press  <b>Fuel Feed</b> button to adjust the amount of fuel to be fed into the boiler. After adjusting the required feeding setting from   buttons, press the <b>ENTER</b> button to store it. Press the  <b>Fuel Standby</b> button to set the standby. After setting the standby setting that should be from the   buttons, press the <b>ENTER</b> button to store it.</p>	 
<p>If it is desired to increase the extra energy during combustion, the spiral is driven by pressing the  <b>Manual Fuel Feed</b> button. This button supplies fuel as long as it is pressed, and cuts the feed when the finger is pulled.</p>	
<p>It will be sufficient to press the  <b>ON / OFF</b> button to turn off the boiler. Unless the power is disconnected (power failure, removal of the boiler plug), the pump will continue to run until the temperature drops.</p>	



**To manually burn and burn:**

Big fuel parts like log wood that are wanted to be burned in the boiler are placed inside the boiler by opening the top cover.

Open the control panel by pressing the  **ON/OFF** button of the device for 1 second. The boiler is put into manual feeding by pressing the  **Wood Mode** button. In wood mode;  **Gearmotor On / Off** and  **Manual Fuel Feed**,  **Fuel Feed** and  **Fuel Standby** will not work.

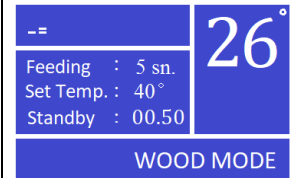
The boiler does not work because the  **Gearmotor On / Off** and  **Fan On / Off** button is not pressed in the side display.





It is useful to set the boiler water temperature at 60°C for the first time. To do this, first press the  **Temperature Setting** button on the panel. TEMPERATURE SET will appear on the screen. You can hold down the   buttons until the temperature level you want to adjust.

When it reaches the desired degree, you can save it by pressing the  **ENTER** button.



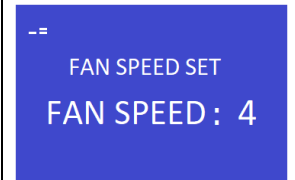

Press the  **Fan Setting** button of the panel. The rectangle will appear around the line in the upper left corner.

When you press the  button once, you increase the fan stage once again, as in the second figure, the moment you press the  **ENTER** button, the fan setting you have memorized and the image on the screen will be as in the third figure.

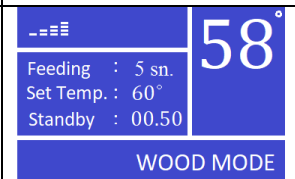

Ignite the ignition aids you put in the boiler. Then close the boiler covers tightly and press the  **Fan On / Off** button on the panel. The Fan lamp on the top right of the control panel will illuminate and the boiler will continue to heat.



It will be sufficient to press the  **ON / OFF** button to turn off the boiler. Unless the power is disconnected (power failure, removal of the boiler plug), the pump will continue to run until the temperature drops.

## FUEL FEEDING – STANDBY ADJUSTMENT

ÜNMAK DUOPEL serisi kazanların kontrol panelinden ayarlanabilen, otomatik beslemeli çalıştırma besleme ve bekleme ayarları için tablo tablosu kullanılabilir.

ÜKY/DUOPEL	Feeding (sec)		Standby (sec)	
	Min	Max	Min	Max
25 kW	3	5	50	1:10
40 kW	4	6	50	1:10
60 kW	5	8	50	1:10
80 kW	7	10	50	1:10
100 kW	10	15	50	1:10



***Do not open the boiler covers and the hopper cover during power cuts, do not add water to the boiler.***



***The values given according to the capacities in the table will vary according to the chimney draft and the thermal comfort demand of the space.***



***In power cuts; close the flue flap, if any. If the pump bypass line is available, activate the line. When the electricity comes, do not forget to return your settings.***

Features of water suitable for filling in boiler installation

Parameter	Unit	Boiler feeding water	Boiler adding water
Appearance	-	Clean, clear, free from solids and stable foam	
Conductivity at 25 °C	µS/cm	<1500	
pH at 25 °C	-	>0,7	9,0 dan 11,5
Total hardness (Ca+Mg)	mmol/l	<0,05	
Ferrite concentration	mg/l	<0,2	
Compound alkali value	mmol/l	-	<5
Diesel / oil concentration	mg/l	<1	-

## CARE AND BOILER CLEANING

---

In order for your system to operate efficiently, regular maintenance is required by expert teams, according to the manufacturer's instructions.

### Regular checks:

- The water level should always be checked. The hydrometer (water level indicator) should be marked after the first filling of the system. If the water level has fallen below the static pressure or system setting, water must be added to the system (when the boiler is cold). To protect the system and the boiler against corrosion, the water to be fed to the system must be softened according to the local settings.
- It should be checked whether the front covers are closed properly and if necessary, the cover wicks should be changed.
- Check whether there is gas leakage from the flue connection. If there is a leak, it must be repaired.
- Boiler heating surfaces should be checked. Soot formation varies according to the type of fuel used and the amount of combustion air. If it is understood that the leaving water temperature does not rise to the values that it is usually in the usual conditions, the boiler surfaces are processed, the heat transfer surfaces of the boiler should be cleaned.
- The fan should be checked for proper operation. The fan that is not working properly and balanced, makes periodic noises. If there are fuel dust or ash collected between the blades of the fan, it is necessary to clean it by blowing or holding a dryer without disturbing the blades of the fan.

### Cleaning the boiler:

It should be done when the boiler is cold. Before cleaning the boiler, the pump and electrical devices connected to the system must be turned off.

### To clean the boiler:

- Between the water jackets should be cleaned one by one. This cleaning should be done frequently since the ashes and institutions remaining on the water jackets will prevent heat transmission.
- Pitching that occurs on the walls of the boiler creates a layer, which will prevent the energy released in the boiler from passing into the water, thus causing low efficiency. In order to prevent this situation, all heating surfaces of the boiler should be cleaned at regular intervals or as required.
- The ashes that can remain on the water grill are pushed down and the ashes accumulated inside the cleaning door at the front of the burner should be cleaned periodically or as required.
- By opening the cleaning cover of the burner, the ashes accumulated in it can be cleaned in certain periods.
- The control panel should be protected from dust, moisture and water. The terminals behind the panel must remain dust-free.
- Boiler outer fairing sheets can be cleaned as required.

### Maintenance:

Contracted service of the system before each working season; we strongly recommend you to call our authorized service to check the boiler, installation, electrical connections, chimney. Never carry out maintenance work without the help of an expert.

---

---



**INFORMATION ON USAGE ERRORS**

<b>PROBLEM</b>	<b>CAUSE</b>	<b>SOLUTION</b>
Insufficient heating	<ul style="list-style-type: none"> <li>Boiler heat transfer surfaces can be covered with work and soot</li> <li>Used fuel may be of poor quality</li> <li>Pump may not be running</li> <li>Insufficiency of insulation</li> <li>Feed - Standby settings may be incorrect.</li> </ul>	<ul style="list-style-type: none"> <li>Clean with cleaning rod (the boiler should not burn)</li> <li>Change your fuel and take a little before refueling.</li> <li>Call service, make sure that the control panel is plugged in.</li> <li>Increase the heat insulation of the space where the boiler is installed</li> <li>Enter the correct settings from the Feed - Standby settings page. Or correct the settings by observing the flame.</li> </ul>
Burning is not good	<ul style="list-style-type: none"> <li>Combustion air may be low</li> <li>Chimney exdraft may be low</li> </ul>	<ul style="list-style-type: none"> <li>Make sure that the fan is working and that the valve is not closed.</li> <li>Check that there are no holes or cracks in the chimney. If you still can't, consult your leg.</li> <li>Isolate your chimney.</li> </ul>
Smoke from the hopper	<ul style="list-style-type: none"> <li>The wick on the hopper cover may not be well pressed or worn on the surface.</li> <li>Chimney exdraft may be low</li> </ul>	<ul style="list-style-type: none"> <li>Make sure that the roving on the cover is fully pressed against the surface, and replace if necessary.</li> <li>Check that there are no holes or cracks in the chimney. If you still can't, consult your leg. Have your chimney sealed.</li> </ul>
Smelting of smoke pipes	<ul style="list-style-type: none"> <li>Burning of plastics-derived fuels in the boiler</li> <li>The chimney may not heat up</li> </ul>	<ul style="list-style-type: none"> <li>Do not dispose of wastes of plastic derivative into the boiler or fuel reservoir (hopper).</li> <li>Check that there are no holes or cracks in the chimney. If you still can't, consult your leg. Have your chimney sealed.</li> </ul>
Excessive fuel consumption	<ul style="list-style-type: none"> <li>Poor use of fuel may be</li> <li>High chimney draft</li> <li>Air may be too high</li> <li>Space isolation may be insufficient</li> <li>Feed - Standby settings may be incorrect</li> </ul>	<ul style="list-style-type: none"> <li>Change your fuel</li> <li>Check that there are no holes or cracks in the chimney. If you still can't, consult your service.</li> <li>Reduce fan speed.</li> <li>Increase the heat insulation of the space where the boiler is installed</li> <li>Enter the correct settings from the Feed - Standby settings page. Or correct the settings by observing the flame.</li> </ul>
Smoke gas leak from the boiler front doors	<ul style="list-style-type: none"> <li>Cover seals may be worn</li> <li>Covers may be deformed</li> </ul>	<ul style="list-style-type: none"> <li>Replace the seals.</li> <li>Ensure that combustion does not withstand the covers. Consult the authorized service center for deformed caps.</li> </ul>
Failure of the boiler to reach the set temp.	<ul style="list-style-type: none"> <li>Temperature sensor tip may be pulled out of the slot</li> <li>The control panel may not be receiving power</li> </ul>	<ul style="list-style-type: none"> <li>Replace the temperature sensor end of the control panel board by lifting the boiler top cover. Pour the heat transfer oil into the housing.</li> <li>Connect the control panel to the mains. If not, call for service.</li> </ul>
Heating of the expansion tank	<ul style="list-style-type: none"> <li>Expansion tank may be affected by pump</li> </ul>	<ul style="list-style-type: none"> <li>Increase the expansion tank or lower the pump speed.</li> <li>In case of open expansion, if the pump is rotating, take it to the outgoing line.</li> </ul>
Partial heating of radiators	<ul style="list-style-type: none"> <li>Air in the radiator</li> </ul>	<ul style="list-style-type: none"> <li>Remove air from radiator purifiers. Make sure that the line to the expansion tank is constantly upward.</li> </ul>

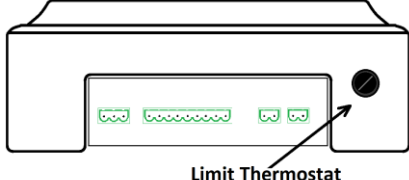
PROBLEM	CAUSE	SOLUTION
Burn out	<ul style="list-style-type: none"> <li>Air may be supplied by the fan at very high flow rate without full ignition</li> <li>Very high fuel supply</li> </ul>	<ul style="list-style-type: none"> <li>Reduce the fan air setting.</li> <li>Reduce the feed setting from the fuel supply setting.</li> </ul>
Noise of noisy water from the boiler	<ul style="list-style-type: none"> <li>There may be air left in the boiler to fill the first water</li> </ul>	<ul style="list-style-type: none"> <li>Refer to the initial start-up.</li> </ul>
Boiler water temperature was too high, now dropped but boiler not working	<ul style="list-style-type: none"> <li>Limit thermostat may be switch off</li> </ul>	<ul style="list-style-type: none"> <li>Tear off the black plastic cover on the back of the control panel. Activate the limit thermostat by pressing the red pin.</li> <li>Turn the control panel off and on.</li> </ul> 
Fuel exhausted warning on the panel	<ul style="list-style-type: none"> <li>Fuel depletion in the hopper</li> <li>Probe dislocation</li> <li>Probe does not feel</li> <li>The boiler water temperature drops too low after reaching the set temperature</li> </ul>	<ul style="list-style-type: none"> <li>If using automatic, add fuel to the hopper, manually load fuel if mechanical feeding is used.</li> <li>Replace probe or call service</li> <li>Replace probe or call service</li> <li>If using automatic, add fuel to the hopper, if using mechanical feeding, manually add fuel.</li> </ul>



**Increasing the fan speed more than necessary will cause some heat to be thrown out of the chimney. Air that comes out suddenly and in large quantities during combustion will cause adherence in slags.**



**"Fuel Feed", "Fuel Standby", "Gearmotor On / Off", "Manual Fuel Feed" buttons will not work in "Wood Mode".**



**While automatic feeding, you can switch to "Wood Mode", but you cannot switch from "Wood Mode" to automatic feeding. To switch from "Wood Mode" to automatic feeding, you can switch to automatic feeding after pressing the "ON / OFF" button and turning off the boiler.**



**The boiler covers and the hopper cover should not be left open during combustion.**

## ÜNLÜSOY YAPI MALZEMELERİ SANAYİ ve TİCARET LİMİTED ŞRKETİ

Pancar Organize Sanayi Bölgesi, 2. Etap No:2, Torbalı – İZMİR

Tel: 444 35 32, Faks: 0232 469 2412

www.unmak.com