



Wood Gasification Boiler User Manual



ÜNLÜSOY

Yapı Malzemeleri Sanayi ve Ticaret Ltd. Şti.
Pancar Organize Sanayi Bölgesi, 2. Etap No:2, Torbalı - İZMİR
Tel: 444 35 32, Faks: 0232 469 2412
www.unmak.com





INDEX

INDEX.....	2
INTRODUCTION	3
SHIPPING AND TRANSPORTATION	4
SELECTION OF INSTALLATION PLACE	5
SAFETY PRECAUTIONS	7
ELECTRICAL INSTALLATION INSTRUCTIONS.....	9
BOILER FEATURES.....	10
RULES FOR HEATING INSTALLATION	12
CONTROL PANEL AND USER INTERFACE	15
START-UP	15
INFORMATION ON COMBUSTION.....	17
MAINTENANCE AND BOILER CLEANING.....	19
INFORMATION ON USAGE ERRORS.....	20

Dok: KK-25 Rev: 220805

This booklet covers below models:

ÜKY/GSF

25-40-60-80

INTRODUCTION



We would like to thank you for your choice of UNMAK ÜKY/GSF model wood gasification boilers. Please read the user manual carefully before installing and operating your product and keep the user manual for the duration of the product use. Do not touch or mix any part of the product except where permitted in the user manual.

The installation, maintenance and service of the boiler requires a specialist technical team.

These operating instructions and regulations should be considered for the installation of the boiler, selection of the location for installation, installation of the boiler water installation and the design of the chimney.

UNMAK boilers are high-efficiency, steel-based hot water boilers designed to burn only log wood fuel. These boilers are only used for heating of central heating, not suitable for direct use of water. However, it can produce hot water with the help of a water heater or heat exchanger. The energy required for domestic water will be taken from the boiler's energy.

UNMAK boilers convert the chemical energy of the fuel into heat energy by burning and load it onto the water which is the heating fluid. Excessive fuel overcharging to the combustion chamber will cause energy loss and will take longer to burn.



User manual should be read carefully and stored with the associated warranty certificate for the life of the boiler.

SHIPPING AND TRANSPORTATION

UNMAK wood gasification boilers are manufactured from thick sheet. Boilers are sent in a complete package.

1. Boiler Group: It is shipped with boiler insulation and outer jacket covered.
2. Accessories: There is a rake in the boiler package.

Safe transport of the product

ÜnmaK wood gasification boilers are heavy products, so care should be taken when transporting the boiler to the place where it will be installed. The equipment used to lift and transport the product must therefore be of sufficient capacity.

In order to prevent damage to the boiler's outer plates and the boiler during transportation;

It is also convenient to remove the large grates from the forklift stands or the transport ring on the boiler. If the connection ropes are to be passed under the boiler when lifting by crane, preventive action should be taken to prevent the top of the boiler from being crushed by the ropes. The boiler standing on the floor should be taken by the crane should not be pulled. When transporting in cold weather, the boiler should not be lifted suddenly in case of freezing of the rope from the cold.



When removing the packaging around the boiler, hard and sharp objects should not be used to prevent damage to the painted boiler plates under the packaging.



SELECTION OF INSTALLATION PLACE

The space where the boiler is installed must have sufficient free space for the installation, combustion and maintenance of the boiler. It must be spaced from the wall for service needs. For this purpose, the dimensions in the paragraph titled “Installation location dimensions” must be applied.

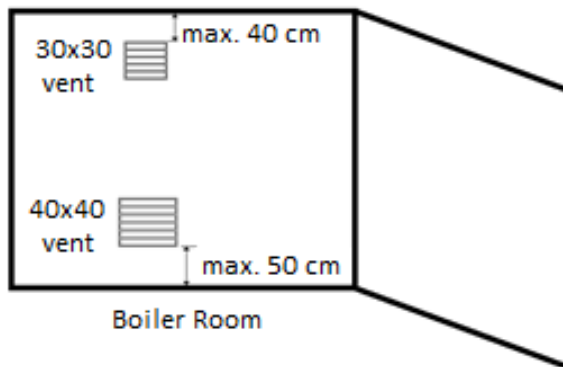

There should also be sufficient air circulation for efficient combustion, the chimney design must meet the required draft values for the model used and comply with the construction criteria given in the manual. The boiler should never be installed in open spaces, balconies, living areas (kitchen, living room, bathroom, and bedroom), explosive and flammable materials.

It is recommended to have a threshold of at least 10 cm in the doors opening into the building from the boiler room. If it is possible to illuminate the boiler room naturally, it should be ensured that the lighting openings do not come under the other windows of the building. If artificial lighting is done, a system that does not dazzle but illuminates the apartment must be properly installed. The main switchgear and panels for the boiler room should be placed around the entrance door and should be of leak-proof type. There should be a fire tube in the boiler rooms.

The boiler room must have at least 1 piece 6 kg dry powder dry fire extinguisher and at least 1 fire cabinet in large boiler rooms.

If natural gas or liquid fuel boilers are also used in the same boiler room, a tear surface must be designed.

The installed space must be directly connected to the external environment, allowing the access of fresh air. One of the grilles should be at most 40 cm below the ceiling of the boiler room and the other should be at least 50 cm above the floor. These grilles should be open continuously. The lower vent should be at least 40 x 40 cm and the upper grille should be at least 30 x 30 cm. Pets should not be fed, smoke and any food and beverages that may be affected should not be stored in the boiler room (boiler room).

All electrical and water installations must be carried out by authorized plumbers, in accordance with all applicable legal and technical rules and regulations.

The fuels to be burned in the boiler should be kept at a distance of at least 800 mm. It is recommended to store fuels in a separate space.

Boilers must be installed on a concrete base 10 cm above the base to protect the solid fuel from the moisture of the water. Laying of tiles with tile and tile stones facilitates cleaning.

Mounting dimensions:

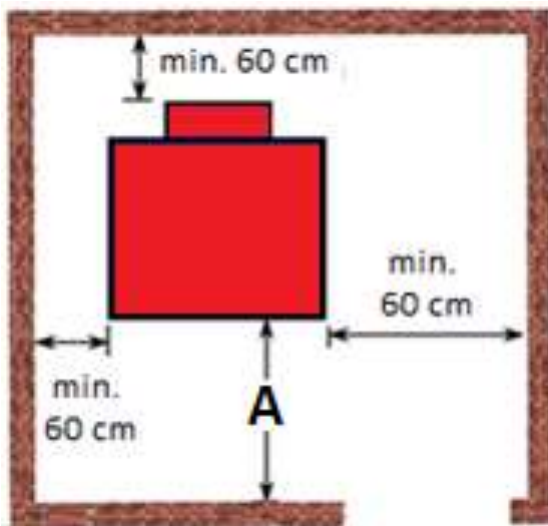

The boiler room must be of a size to provide the minimum dimensions given in the picture below. When the boiler is placed, sufficient distance must be left to ensure that the service is comfortable.

Dimension A: 60 cm greater than the opening of the boiler door;

If the above measurements are observed, a minimum of 8 m³ of volume requirement in the regulations is ensured.



It is inconvenient to have flammable, caustic and flammable materials in the boiler room.

SAFETY PRECAUTIONS

The boiler must be connected to a chimney in accordance with the specifications specified in the operating instructions and the relevant regulations. The chimney must provide the draft value required by the connected boiler. Your boiler should not be operated without a chimney connection and there must be enough draft to burn. In chimneys where sufficient draft is not ensured, the boiler must never be operated. Any installation in the place where the boiler is installed should not be installed.

In case of boiler changing in the boiler room, the old boiler must be removed or disconnected from the chimney and the insulation must be sealed and insulation should be made. In no case should more than one boiler be connected to the same chimney. The cylindrical chimney can be passed through the chimney in the figure.

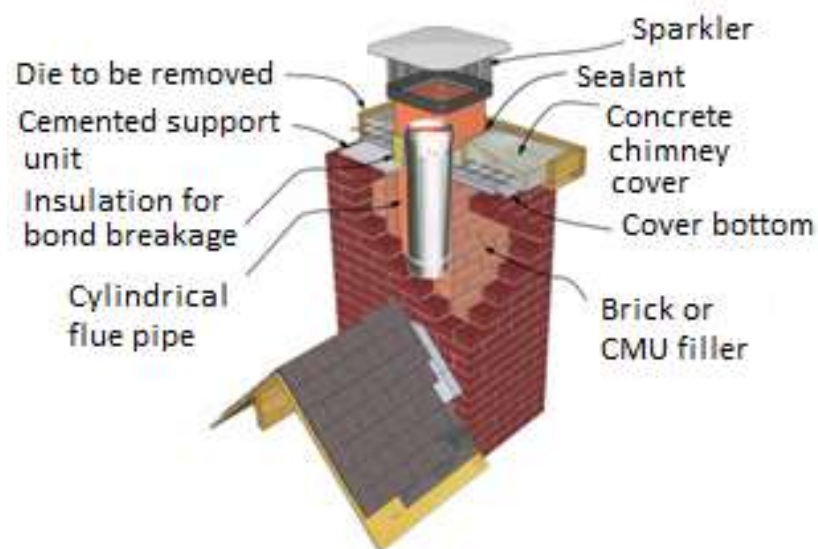

Smoke chimneys should not be placed on the outer wall of the building unless it is a technical requirement. The wall thickness of the chimney walls should not be less than a brick thickness. For chimney construction, hollow bricks and briquettes should never be used. It should be plastered inside and outside of the rectangular chimney.

It should be ensured that fresh air is continuously introduced into the area where the boiler is installed. Reference must be made to the dimensions specified in this manual. The boiler should never be installed in living spaces or in a place directly connected to such a place. In order to reduce the risk of scaling and corrosion in old and new installations, the instructions given in the relevant section of this manual should be applied by the installer who installs the boiler. In particular, if the boiler is connected to an old installation, it is necessary to clean the waste completely before installation. The installation must be cleaned and cleaned several times.

Avoid overloading fuel into the boiler and check the suitability of combustion frequently. For any reason, direct cold water should not be added to the overheated boiler for cooling. This can cause noise in the installation, excessive thermal stresses in the boiler and thus permanent damage. The water in the installation must not be drained unless there is a risk of maintenance or freezing. The system design should ensure that the ratio between the water flow rate and the boiler capacity is not exceeded and the difference between the boiler inlet and outlet water temperatures of 20°C is not exceeded. In order to minimize the water missing in the installation, the water level should be checked regularly and the leaks in the system should be removed. Because excessive water additions to the system will cause lime accumulation on the water side of the boiler and this will cause regional overheating and this will damage the boiler.

The boiler must not be burned directly, it must be installed on a level surface. It is recommended that the height of the base on which the boiler is to be installed shall be at least 10 cm and its width is wider than the outside dimensions of the boiler. Thanks to the base, the boiler is protected from the water that can accumulate on the ground.

The fire should not be approached when the lid of the burning boiler is open;



Do not add water when the boiler is hot.



Electrical installation of this product must be done by qualified personnel in accordance with the explanations given in this manual and applicable local or national regulations.



THIS PRODUCT MUST BE CONNECTED TO THE ELECTRICITY WITH EARTH LINE!



There should be no faulty and unsafe power lines in the boiler room.



The 230 V electrical connection from the control panel must be connected to the mains via the W automaton.



The boiler should not be installed in closed and living areas.



ELECTRICAL INSTALLATION INSTRUCTIONS

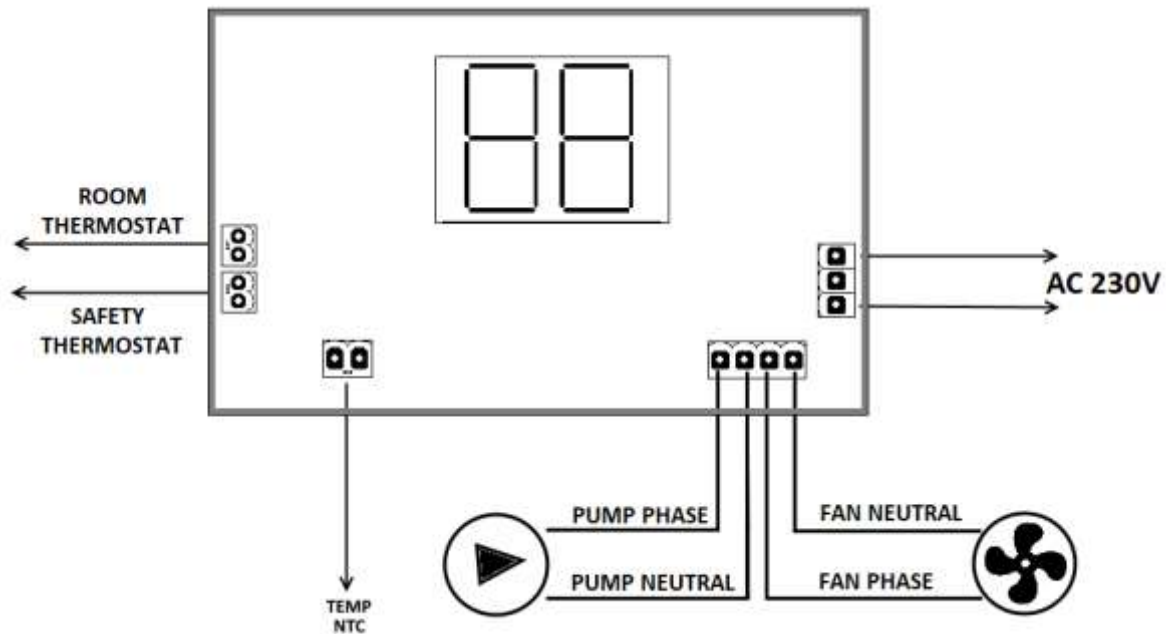

ÜNMAK ÜKY / DUO series boilers are fed with 230 Volt mains voltage. Where the mains voltage is less than ten percent or greater than ten percent, the regulator should be used.

The control panel should be connected to a wall panel with suitable grounding equipment, the distance between the boiler panel and this wall panel should not exceed 50 cm.

Separate grounding installation must be made from the column installation for each boiler room.

Grounding installation:

- a) 0.5 m², 2 mm. thick copper sheet,
- b) 0.5 m², 3 mm. thick galvanized plate (hot dip) or
- c) Solid copper rod should be made with electrodes.

Copper rod electrodes must be at least 1.5 m in diameter of $\varnothing 16$ mm or at least 1.25 m in diameter of $\varnothing 20$ mm and the earthing resistance of rod electrodes must remain below the limits of 20 Ω . (Neutral-Earth voltage $\leq 3V$)

In all three cases, copper electrodes or plates must be connected to the natural gas installation by soldering or welding, using a minimum of 16 mm² multi-stranded (braided) copper cable and conductive lug. Copper electrodes or plates should be placed completely in the ground as teeth, and the conductor remaining on the ground should be connected with the pipe casing and the main table of the boiler room.

BOILER FEATURES

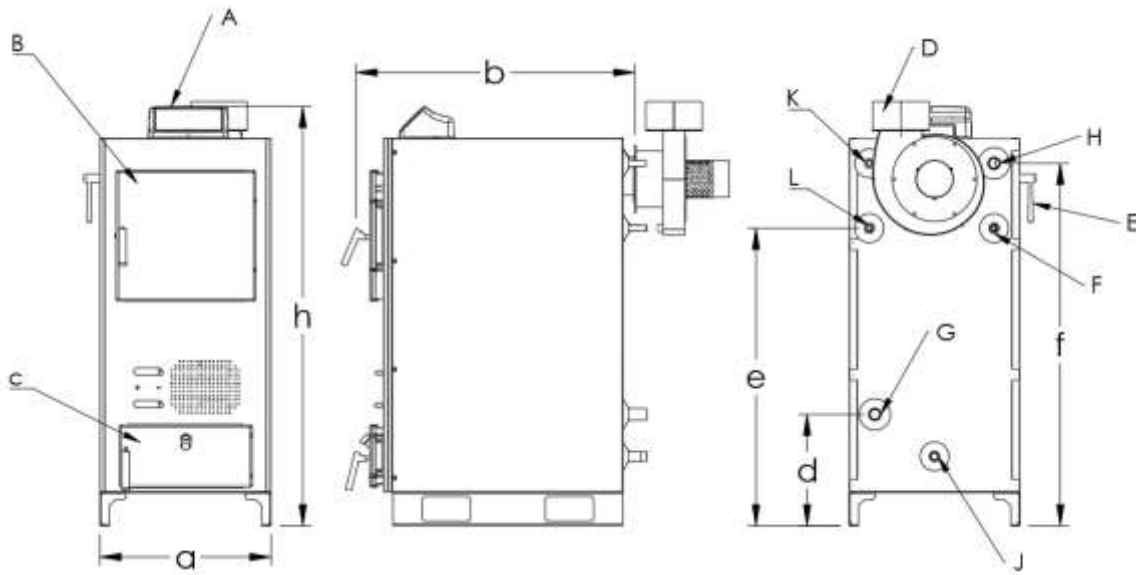

TECHNICAL SPECIFICATIONS						
Model	ÜKY/GSF		25	40	60	80
Power	kW		25	40	60	80
Efficiency	%		> 90			
Recommended Fuel Type			Log Wood (recommended to be free from moisture)			
Recommended Fuel Dimensions	mm		Ø80 x 550			
Burning Chamber Height	mm		420	724	1124	
Burning Chamber Width	mm		370	370	460	568
Burning Chamber Length	mm		575			
Burning Chamber Volume	Lt		89	154	297	367
Fuel Entry Dimensions	mm		410x208	410x385	502x510	630x510
Water Volume	Lt		97	110	255	308
Boiler Weight	kg		410	475	650	776
Required Draft	Pa		15 - 18		20 - 25	
Emission Rates (CO)	mg/m ³		< 250			
Min/Max Operating Temperature	°C		40 - 80			
Water Return Temperature (Recommended)	°C		40			
Max. Operating Pressure	bar		3			
Test Pressure	bar		4			
Dimensions	Length (a)	mm	607	607	720	850
	Depth (b)	mm	1010	1010	1107	1107
	Flue Connection Height (c)	mm	1150	1504	1850	1850
	Water Return Connection Height (d)	mm	395			
	Cooling Exchanger Connection Height (e)	mm	755	1055	1455	1455
	Water Flow Connection Height (f)	mm	985	1285	1685	1685
	Total Boiler Height (h)	mm	1185	1485	1945	1945
Flue Diameter	mm		160		200	
Min-Max Flue Temperature	°C		190 - 210			
Boiler Flow-Return Connections	R"		1"	1 ¼"	1 ½"	1 ½"
Safety Flow-Return Connections	R"		1"			
Filling-Discharging Connections	R"		½"			
Cooling Exchanger Connections	R"		½"			
Electricity Connection	V/Hz		230 - 50			

The right to make changes in dimension is reserved.

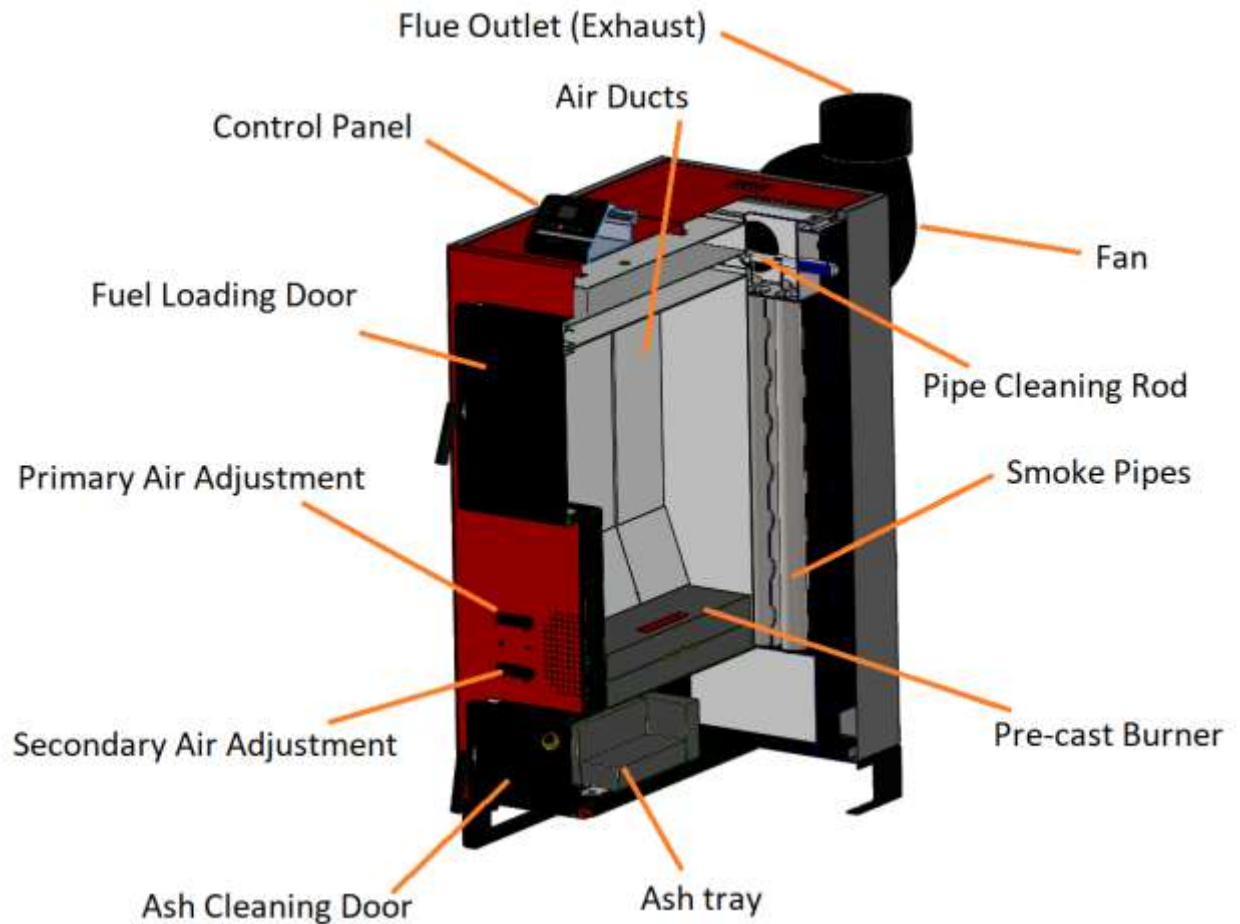

Heat resistant solid refractory burner (precast burner) is special solid high corundum refractory burner with reinforcement additives against thermal stresses and wetness will operate up to 1400°C, and ensures good mixture of wood gas with secondary air, rising combustion and emissions.

Integrated cooling loop for safety against overheating is a cooling loop made from copper tube is integrated inside the boiler. Body of water and outlet connections of this cooling loop is outboard at the highest of the boiler. A safety valve to activate the utility at high water temperatures ought to be hooked up for correct work of safety system. Whether or not the hydraulic circuit is open ventilated or pressurized, the protection valve ought to be utilized inside the system for meeting the rules of related European commonplace for this product, as well as the safety of whole heating installation and also the boiler itself.

RULES FOR HEATING INSTALLATION

Pay attention to the figure on the right while positioning the pump. When assembled, the junction box with the electrical terminals of the pump should not come down. The rotor part of the pump should not be pointing down.

When the circulation pump is installed, the failure of the electrical connections to come down will eliminate the problem of entering the water into the pump.

Perpendicular installation of the shaft should also be avoided in order to prevent the pump shaft from pressing the housing or the outer cover during operation.

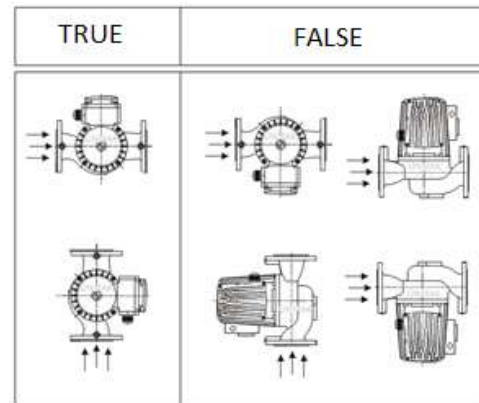

Expansion tank:

In hot water heating systems, when the water is heated from 10°C to 90°C, its volume increases by 3.55% in its first volume. Expansion tanks are used in order to obtain this expansion due to the temperature in the water. Expansion tanks also fulfill the safety of the system, that is, the pressure does not rise, and the necessary water support functions for the system.

Open expansion tanks:

At the top of the system, the roof is put on the level difference and works open to the atmosphere. An expansion tank is placed at a slightly higher point than the highest point of the dispensing system to collect the expanded water volume. The water that expands in the boiler is stored in the expansion tank by means of a travel safety pipe. When the water in the installation cools, the water of the installation is completed by the expansion tank by means of the return safety pipe. As the expansion tank also opens the system to the atmosphere, it ensures the safety of the system by preventing the pressure in the heating installation to rise above atmospheric pressure. The venting pipes are opened from the expansion tank to the atmosphere and the air in the system is discharged. It is recommended to use separate expansion tanks according to their capacities for each boiler in the installation. That is, it is not correct to connect the two boilers to a single expansion tank. There are return and return safety pipes for each boiler and expansion tank. Valves, check valves etc. on these safety pipes. No fittings such as material should not be installed. Safety pipes must reach the nearest point of the boiler inlet and outlet by the shortest vertical path. Horizontal movement is only allowed at the level of the expansion tank and at minimum length.

Expansion tank volumes that must be rated according to the rated boiler capacity

Boiler Power (kW)	Open Expansion Volume (lt)
25	50
40	50
60	90
80	110

Open expansion tanks were selected by considering the open expansion volumes of Ünmak brand and panel radiator in the system.

ÜKY/GSF boilers must be connected to an installation with an open expansion tank in accordance with the installation diagram shown below. The circulation pump can be connected to the return or return line. If the pump is in the boiler return; the open expansion tank must be higher than the discharge head of the pump.

Warning about the water level:

After the first water is pressed into the system, the minimum water level must be marked on the hydrometer. Water level should be checked on a daily basis and water should be added to the installation when it falls below the minimum value.



Adding fresh water to the installation should only be carried out when the installation is cold.



Before installing a new boiler in the old heating installation, the installation must be washed several times with water.



The chimney must be cleaned before installation into the old chimney installations.



Each boiler chimney must be detached. Never connect more than one boiler to the same flue system.

Warning of corrosion in installation:

UNMAK boilers are extremely resistant to corrosion. However, all iron-based components in the heating installation (including installation pipes and radiators) must be protected against corrosion. Oxygen in the heating water causes oxidation of the iron surfaces resulting in rust and thus loss of material.

During the initial filling of the installation, the accumulated air must be evacuated. Usually, if the necessary measures are taken after the first filling, there is no damage caused by the oxygen in the water. Oxidation is mostly caused by oxygen which is involved in the heating water during operation.

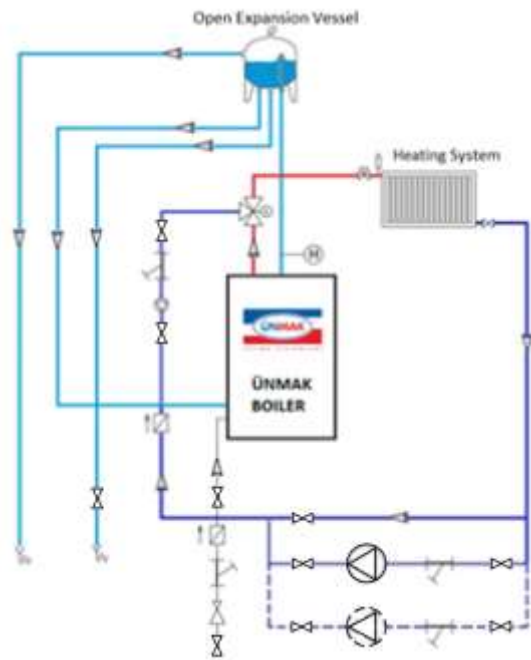
**Warning against frost protection:**

The heating installation must be completely isolated. Outdoor parts of the installation should be isolated more than the interior. If operating with an open expansion tank, the return and return pipes to the expansion line must be isolated or even the expansion tank must be isolated.

Considerations in new installations:

To minimize the addition of fresh water system design and sizing should be done correctly. None of the materials used in the installation must have a gas permeability. A maximum of 50 micron filters of synthetic or metal porous must be placed on the fresh water splicing line.

Considerations for heating connected to old installations:



A long-term heating system produces a protective layer (black magnetite) on metal surfaces in contact with water. When a new boiler is installed in the old system, the clean surfaces of the boiler will be the first place to start corrosion. Therefore, when a new boiler is connected to the old heating system, in addition to the measures to be taken for new systems, the following issues should be considered:

1. The old system must be thoroughly rinsed to remove any impurities and sediments from the boiler before connecting.
2. A manual valve air separator must be installed at the top of the system.

CONTROL PANEL AND USER INTERFACE



Buttons and Explanations

ON/OFF button		It is used to turn the device on and off and to save the entered values.
TEMPERATURE		It is used to determine the temperature at which the fan will stop. Pressing the (+) button next to it increases the temperature, pressing the (-) button decreases the temperature.
FAN		In ÜKY/GSF type models, the fan speed changes automatically depending on the temperature.













START-UP

The following steps should be followed for the initial start-up:

- Check if there is a visible defect in the installation. If there is a problem, correct the problems by getting information from the "Information on Usage Errors" page.
- Observe from the hydrometer whether the water is decreasing in the installation. Add water if missing
- Check whether there is a visible malfunction in the electrical line of the boiler. If there is a problem, correct the problems by getting information from the "Information on Usage Errors" page.

When the panel is energized, the oF logo appears on the screen. It shows the boiler water temperature when the on/off button is pressed.

Parameter Settings

- While the On/Off button  on the panel is closed (oF is written on the screen), the Temperature button  is pressed for 3 seconds.
- The menu can be navigated by pressing the  or  buttons.
 - In order to change the parameter value, the On/Off button  is pressed and the value is changed with the   or   buttons.
 - Press the On/Off button  again for recording or wait for 6 seconds to record itself.
- When the menu is entered, the pump continues to run, the fan stops.
- To exit the menu, press the On/Off button  to exit the menu when Pr appears on the screen with the  or  buttons.

Parameter	Min-max	Default
P1 Pump switch-on temp.	35 – 45	40
P2 Pump switch-off temp.	27 – 32	30
P3 “No fuel” temperature	20 – 25	24
P4 Hysteresis	2 – 10	03
Pr Exit the menu		

Error Codes

H1	“No fuel”
H2	Temperature probe error
H3	Sıcaklık probu yüksek sıcaklık ölçümü
H4	Emniyet (Limit) termostat yüksek sıcaklık ölçümü



Do not use flammable substances to ignite.

INFORMATION ON COMBUSTION

In order to ensure correct combustion, as a general rule, the air supplied to the fuel must be at a certain rate. The air required for a certain amount of fuel should not be too much. If the amount of air which is changed depending on the type of fuel is less than the required amount of carbon monoxide, the energy produced is reduced, the combustion starts, the combustion efficiency decreases, the air quantity is decreasing, the carbon monoxide decreases while the non-combustion air is heated from the chimney by heating in the furnace, the combustion is deteriorated and the combustion efficiency it decreases.

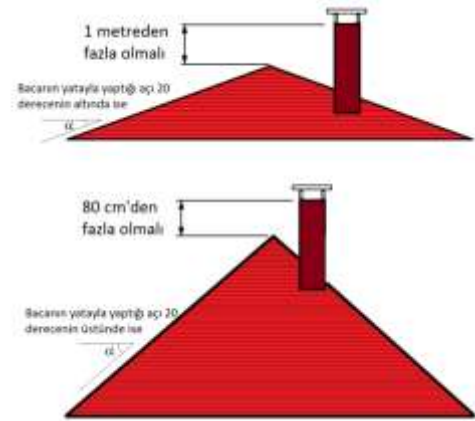

If the temperature of the flue gas is above the accepted values, excess energy will be ejected from the

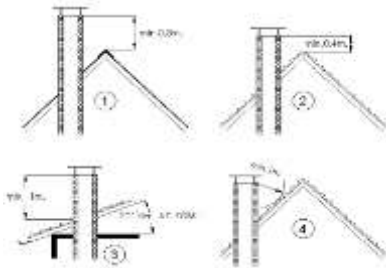

flue to the atmosphere. The material, the way of construction and the connection of the chimneys are important in terms of high combustion efficiency, low heating cost and protection of the environment.

The chimney must be good for burning to be good. It is recommended to use a high temperature resistant firebrick and stainless steel chimneys. The horizontal smoke ducts should be connected to the

chimney with a slope of at least 5% and the length should never exceed 1/4 of the height of the chimney. The height of the chimney should be well determined. The chimney sections must be circular unless necessary.

Never use a hollow brick on the chimney walls. The most ideal is the creation of fire bricks.

UNMAK boilers must be connected to an independent chimney that can provide the minimum desired minimum traction. Minimum traction is usually min. It should be measured with a manometer in 20 Pa. The part of the waste gas line between the boiler and the chimney should be insulated with glass wool. The waste gas pipe and flue pipe shall be made of steel sheet or material, which is resistant to 400 °C. All connections on the exhaust gas pipe must be sealed to obtain better combustion and efficiency. The waste gas pipe must be connected to the chimney in the shortest way within the dimensions given in the diagram below. Horizontal connections and equipment such as elbows should be avoided.

A vertical steel pipe should not be used as a chimney, the chimney must have an inside and an outer surface. The outer surface may be steel or brick braided. For the inner surface of the chimney, corrosion-resistant stainless steel may be preferred. In order to prevent condensation, thermal insulation should be applied to the space between the inner and outer surfaces of the chimney.

At the lowest level of the chimney, there must be a cleaning lid made of steel that is sealed.

The length of the exhaust gas pipe between the chimney and the boiler must not exceed a quarter of the height of the chimney.

The size of the waste gas pipe and the chimney should be greater than the size of the waste gas outlet (fumes) of the boiler. The boiler chimney installed must be at least 1 meter above the roof of the space and at least 0.4 meter above the tiled roofs.

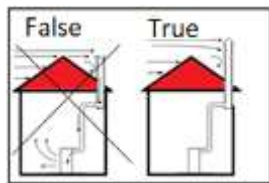

Chimney without chimney head and chimney head

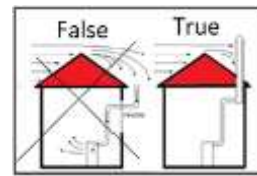

Correctly installed chimney and chimney head with incorrectly installed chimney



Excess air causes high flue temperature, high flue temperature also causes combustion in combustion efficiency.



MAINTENANCE AND BOILER CLEANING

For your system to work efficiently, regular maintenance is required by specialist teams according to the manufacturer's instructions.

Regular checks:

- The water level should always be checked. The hydrometer (water level indicator) should be marked after the first filling of the system. If water level or pressure drops below the static pressure or system setting, water addition (boiler cold) must be done to the system. To protect the system and the boiler from corrosion, the water to be fed into the system needs to be softened according to local settings.
- Check that the front doors are closed properly, and if necessary, the door wickets should be replaced.
- Check that there is a gas leak from the chimney connection. If there is a leak, it must be repaired.
- Boiler heating surfaces should be checked. The formation of the corporation depends on the type of fuel used and the amount of combustion air. If it is understood that the outlet water temperature can not rise to the usual values in usual conditions, the boiler surfaces are treated, the heat transfer surfaces of the boiler should be cleaned.

Boiler cleaning:

It should be done when the boiler is cold.

To clear the boiler:

- Clean between the water jackets with the help of a spatula.
- Bitumen on the walls of the boiler forms a layer, which will prevent the energy that is released in the boiler from passing through the water, thus resulting in low efficiency. To prevent this, all heating surfaces should be cleaned regularly with the help of a spatula or as required.
- Boiler outer cover sheets can be cleaned as needed.

Maintenance:

The system has a contracted service before each working season; We strongly advise you to call our authorized service to check the boiler, fittings, electrical connections, syringe. Never do maintenance work without the help of an expert.



Chimney cleaning should be done by a firm that has successfully passed certification training in your city organized by the fire department chairs.

INFORMATION ON USAGE ERRORS

PROBLEM	CAUSE	SOLUTION
Insufficient heating	<ul style="list-style-type: none"> Boiler heat transfer surfaces may be coated with soot and soot The fuel used may be of poor quality Pump may not be working Isolation failure Overloading the boiler 	<ul style="list-style-type: none"> Clean with a spatula. (the boiler should not burn) Change the fuel and take some fuel before you buy it. Call for service, make sure the control panel's plug is plugged in. Increase the heat insulation of the room where the boiler is installed Load with padding, do not cover all walls of the boiler
The combustion is not good	<ul style="list-style-type: none"> Less combustion air Lack of chimney draft 	<ul style="list-style-type: none"> Make sure the air damper is open Check that there are no holes or cracks in any part of the boiler. If it is not enough yet, consult your abdomen. Have your chimney isolated.
Excess fuel consumption	<ul style="list-style-type: none"> Poor quality fuel High chimney draft Excess air Insufficient space insulation 	<ul style="list-style-type: none"> Change your fuel Check that there are no holes or cracks in any part of the boiler. If it is not enough yet, consult your abdomen. Increase the heat insulation of the room where the boiler is installed
Smoke gas leakage from the boiler front doors	<ul style="list-style-type: none"> Wear of cover wicks Deformation of covers 	<ul style="list-style-type: none"> Change wicks. Ensure that the burner does not rest on the covers. Get help from authorized service centers for deformed covers.
The boiler can not reach the set temp.	<ul style="list-style-type: none"> The temperature may have come out of the sensor housing The control panel may not be receiving power Fuel may be low 	<ul style="list-style-type: none"> Replace the temperature sensor end of the control panel card by lifting the boiler top cover. Pour heat transfer oil into the housing. Connect the plug of the control panel to the power supply. If it still does not work, call the service. Perform fuel loading
Heating of the expansion tank	<ul style="list-style-type: none"> Expansion tank is under pump effect 	<ul style="list-style-type: none"> Increase the expansion tank further or reduce the cycle of the pump.
Partial heating of the radiators	<ul style="list-style-type: none"> Air in radiator The pump is running low 	<ul style="list-style-type: none"> Take the air out of the radiator If there is a speed setting on the pump, increase it, if not, consult your plumber and suggest shortening the lengths of pipe paths.
Noisy water coming from the boiler	<ul style="list-style-type: none"> Air stays inside before the boiler is first filled 	<ul style="list-style-type: none"> See the start up section.
Panel writes Ht1 error (No fuel)	<ul style="list-style-type: none"> The fuel in the boiler is exhausted 	<ul style="list-style-type: none"> Add fuel to the boiler
Panel writes Ht2 error (Temperature sensor)	<ul style="list-style-type: none"> The temperature sensor is not installed or may be removed The temperature sensor may be faulty 	<ul style="list-style-type: none"> Fit the heat sensor firmly Call a service
Panel writes Ht3 error (Limit thermostat)	<ul style="list-style-type: none"> Limit thermostat may be thrown 	<ul style="list-style-type: none"> Wear by turning the black plastic cover on the back of the control panel. Limit thermostat is activated by pressing the red pin.



Do not open the boiler flaps at power cuts, do not water boiler in the boiler.

ÜNLÜSOY YAPI MALZEMELERİ

SANAYİ VE TİCARET LİMİTED ŞİRKETİ

İzmir Pancar Organize Sanayi Bölgesi,
10. Cadde, No:2, Torbalı/İZMİR - TURKEY

Tel: +90 444 35 32

www.unmak.com

ÜNLÜSOY YAPI MALZEMELERİ

SANAYİ VE TİCARET LİMİTED ŞİRKETİ

İzmir Pancar Organize Sanayi Bölgesi,
10. Cadde, No:2, Torbalı/İZMİR - TURKEY

Tel: +90 444 35 32

www.unmak.com